

Shining Future Led Technology Co.,Ltd.

General Description

APA102 is a type ic for the three-color White Diming control strip and string ,This ic using the CMOS process to provide three-color White LED output driver to adjust the output with 256 gray scale and 32 brightness adjustment ,APA with 2 signal output way , one is clock ,another is data, the clock and data is synchronized ,so that the crystal cascade piece of output movement is sychronized .

Feature

- CMOS process,low voltage ,low consumption
- Synchronization of two-lane
- Choose positive output or negative White three-color LED output
- 8 bit(256 level) color set ,5bit(32 level) brightness adjustment
- Build-20ma constant current output
- With self-detection signal build in support for continuous oscillation PWM output ,can be maintained static screen

Application

- LED lamp
- LED Strip ,led pixel module
- LED billboard LED screen

PRODUCT SPECIFICATIONS

Color	LM(lumen)	Refresh rate	Voltage	Power Consumption	Weigh t (g)	An gle	Dimens ions (mm) L*W*H	Operating Temperat ure
White Warm white Cool white	18lm	400 cycle	DC5V	0.2W (MAX:1W)	1	16 0	5x5x1.4	-40-70°C

PHYSICAL DIMENSIONS

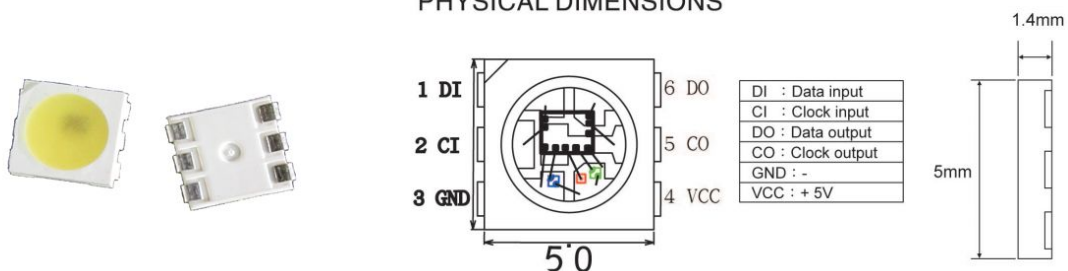

Shining Future Led Technology Co.,Ltd.

(PIN Description)

NO.	PIN NAME	I/O	FUNCTION
1	VDD	P	Power is terminal
2	VREG	O	4.5V regulator output
3	CKO	O	Series with the output clock signal
4	SDO	O	Series with the output data
5	VEN	I	Self-test function selection
6	CSEL	I	Invert the clock signal cascade
7	POLAR	I	Positive and negative output options
8	OSCI	I	Oscillator input
9	SDI	I	Series with the input data
10	CKI	I	Series with the input clock signal
11	REXT	I	Constant current source to adjust side
12	VSS	P	Power supply negative terminal
13	W	O	W LED output
14	W	O	W LED output
15	W	O	W LED output

Shining Future Led Technology Co.,Ltd.

(Block diagram)

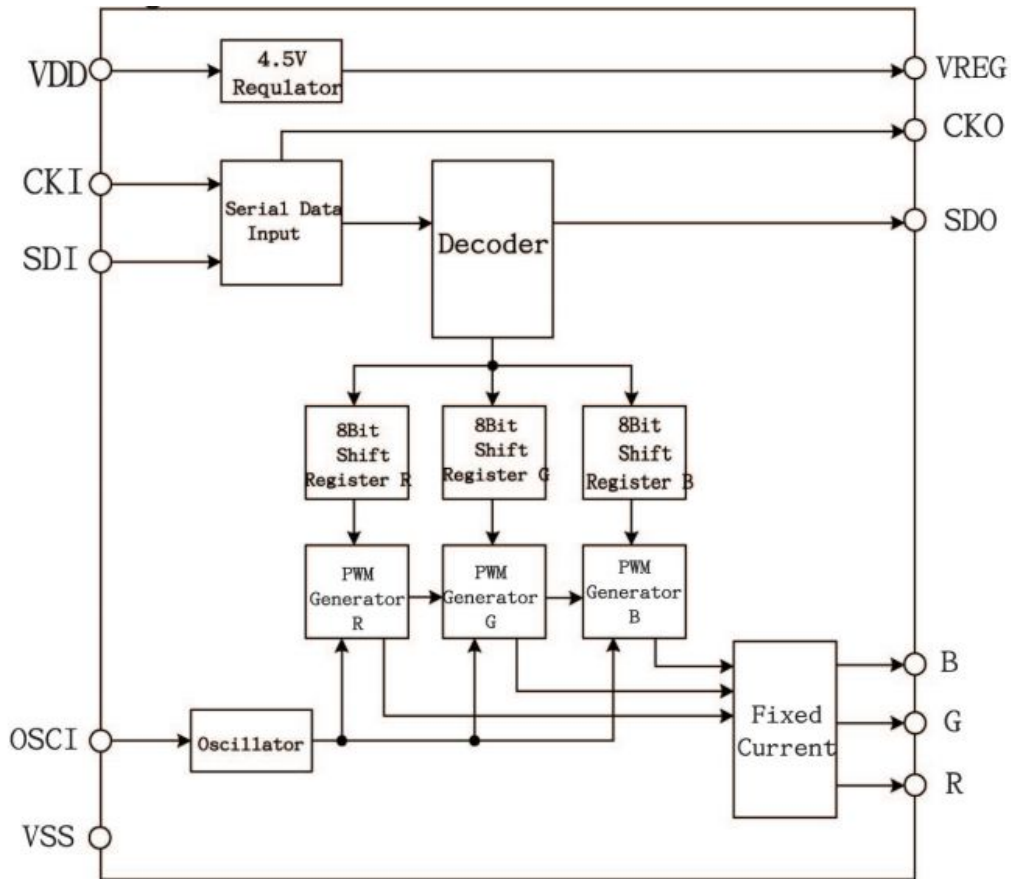

(Absolute Maximum Rating)

Supply voltage ----- -0.3-6.0V

Input voltage----- VSS-0.3 to VDD +0.3V

Operating temperature----- -40 to +70°C

Storage temperature----- -50 to +125°C

Note: Stress above those listed may cause permanent damage to the devices

Shining Future Led Technology Co.,Ltd.

(Electrical Characteristic)

Symbol	Parameter	Condition	Min.	Typ.	MAX	Units
VDD	Supply Voltage			5.0	5.5	V
VIH	Input High Voltage		0.7VDD		VDD+0.3	V
VH	Input Low Voltage		VSS-0.3		0.3VDD	V
LOL	Sink Current Voltage(RGB)	VDD=5V, VOL>1V	22.5	24.5	26.5	mA
RIN	Pull High	VDD=5V		570		kΩ
VREG	Regulator Voltage(VREG)	VDD=5V	4.4	4.5	4.7	V
FOSC	Oscillator Frequency		800		1200	KHz

(Function Description)

(1) cascading data structure

Tabdem N-LED

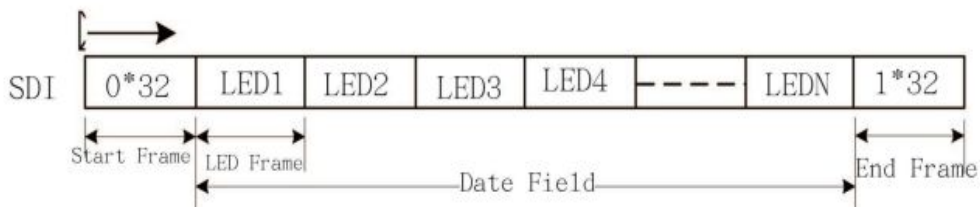

Start Frame 32 Bits

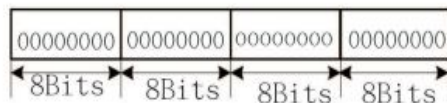

LED Frame 32 Bits



LED Frame 32 Bits

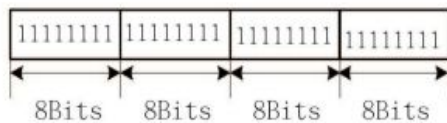

Shining Future Led Technology Co.,Ltd.

Global bit:5 bit (32 level) brightness setting,while controlling W,W,W three-color constant current output value,if set the global bit for the 10000(16/31) is the output current is half again the original PWM settings

DATA MSB←→LSB	Driving Current
00000	0/31
00001	1/31
00010	2/31
.....	
11110	30/31
11111	31/31(max)

PWM input and output signals Relations

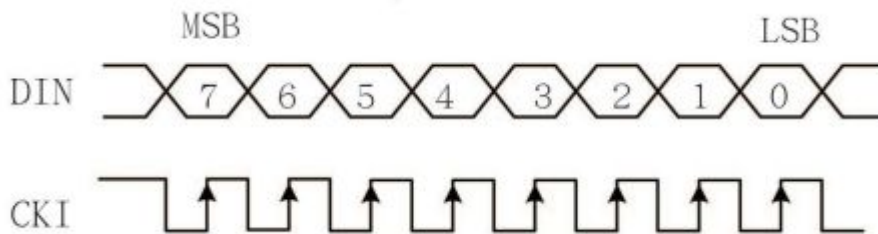

Data MSB--	Duty Cycle
00000000	0/256(min)
00000001	1/256
00000010	2/256
.....	
11111101	253/256
11111110	254/256
11111111	255/256(max)

(2). The number of pixel per second sent to the CKI frequency (FCKI) minus the Start Frame bit divided by the number 40 the number of LED Frame bit 32, if the CKI frequency(FCKI) to 512KHZ. The pixel number $(512000-40)/32=15998$, if the 50 second update Views can be connected in series LED number $15998/50=319$. To increase the number of cascaded IC CKI frequency

(3).POLAR to empty ,W,W,W for the negative output;POLAR access VSS ,W,W,W is positive output

(4).VEN: self-detection

DATA field to the middle of 3 bit is W,W,W in the MSB of the opposite phase,otherwise regarded as invalid data. VEN close to the empty when the self-detection; when VEN VSS then activated self-detection

(5).CSEL to empty when the CKO and CKI,RP:CSEL connected with VSS when the

Shining Future Led Technology Co.,Ltd.

CKO compared with CKI.

Application Circuit

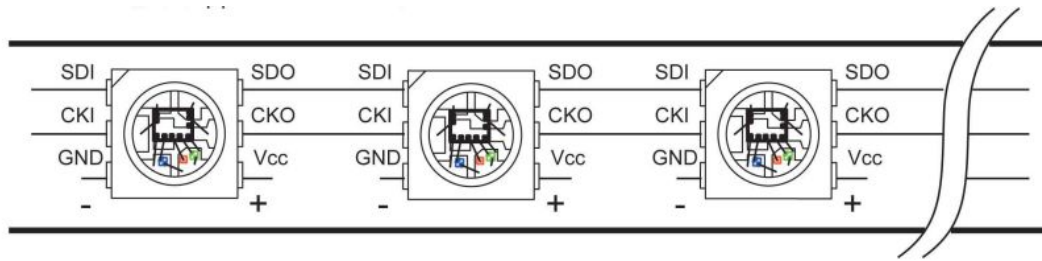

www.sfleds.com